



GÜRDAL ÇELİK KAPI ANONİM ŞİRKETİ

Muratpaşa M. Demirhisar C. No.3 Kat.1/6 T.+90 212 501 21 17
Pk.34040 Bayrampaşa / İstanbul / Türkiye F.+90 212 501 21 18

Mail: info@gurdalkapi.com.tr f gurdalcelikkapi
Web: www.gurdalkapi.com.tr @ gurdalkapi

www.gurdalkapi.com.tr

GÜRDAL ÇELİK KAPI SİSTEMLERİ

2025 KATALOĞU

GÜRDAL 25

ÇELİK KAPI SİSTEMLERİ



A3

İNDEKS

03/04

BAŞKANIN MESAJI

05/52

MODERN DAİRE KAPILARI

53/84

KLASİK DAİRE KAPILARI

85/108

BİNA GİRİŞ KAPILARI

109/138

VİLLA GİRİŞ KAPILARI

139/160

NEEN KAPILARI

161/164

ACİL ÇIKIŞ KAPILARI

165/168

TEKNİK BİLGİLER



05

GRDAL ELİK KAPI 25. YILINDA,
YİNE DİNAMİK YİNE KALİTEDEN ÖDN VERMEYEN
İZGİSİYLE BYMEYE ODAKLANDI.

Bundan tam 25 yıl önce "Hizmette ve üretimde kalite" mottosu ile yola çıktığımız ilk andan itibaren güvenilir olmak, daima temel prensibimiz olmuştur. Bu doğrultuda kurucumuz Dursun Grdal'dan öğrendiğimiz üstün iş ahlakı ve dürüst çalışma hedefi ile müşterilerimize verdiğimiz hizmetin kalitesi şirketimizin vazgeçilmez ilkesi halini almıştır.

Değişime sadece ayak uyduranların geleceğe emin adımlarla yürüyebileceği gerçeğinden hareketle sektörün beklentilerine uygun tasarım ve Ar-Ge çalışmalarına ayrı bir önem vermekteyiz. Bunun için her biri konusunda uzman, bilgili, tecrübeli ve yetenekli çalışma arkadaşlarımız şirketimizin en önemli hazinesidir. Temelinde insan odaklı çalışma prensiplerimize sadık kalarak daima kendimizi yenileyerek aşmak, kalitemizi geliştirerek yükseltmek için ilk günkü enerjimizi, bugünlerin sinerjisiyle birleştirerek oluşturduğumuz çizgimizde yarınlara daha bir umutla bakmaktayız.

40 yıla yaklaşan iş hayatımda başta aileme, çalışma arkadaşlarıma, müşterilerimize ve iş ortaklarımıza bizlere kazandırdıkları değerler için teşekkürlerimi sunuyorum.

Yönetim Kurulu Başkanı
Tuba Grdal Altun

GRDAL
ELİK KAPI SİSTEMLERİ

TEKNOLOJİ ÜRÜNÜ KAPILAR

[MODERN]



ILEX

MODERN DAİRE GİRİŞ KAPILARI

GÜRDÜL
ÇELİK KAPI SİSTEMLERİ



ROSE

ROSE

ROSE



SALVIA

SALVIA

SALVIA

10

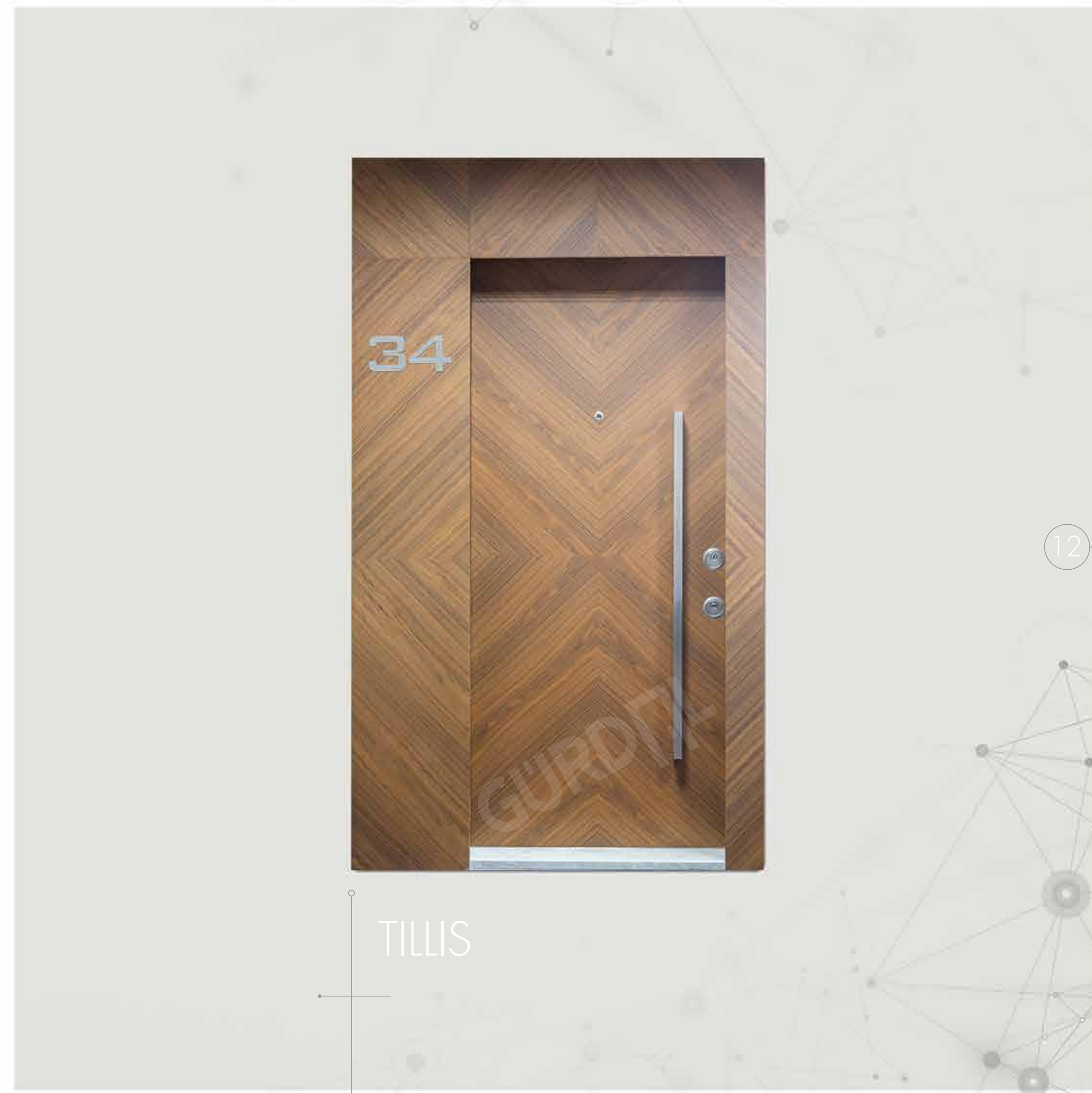
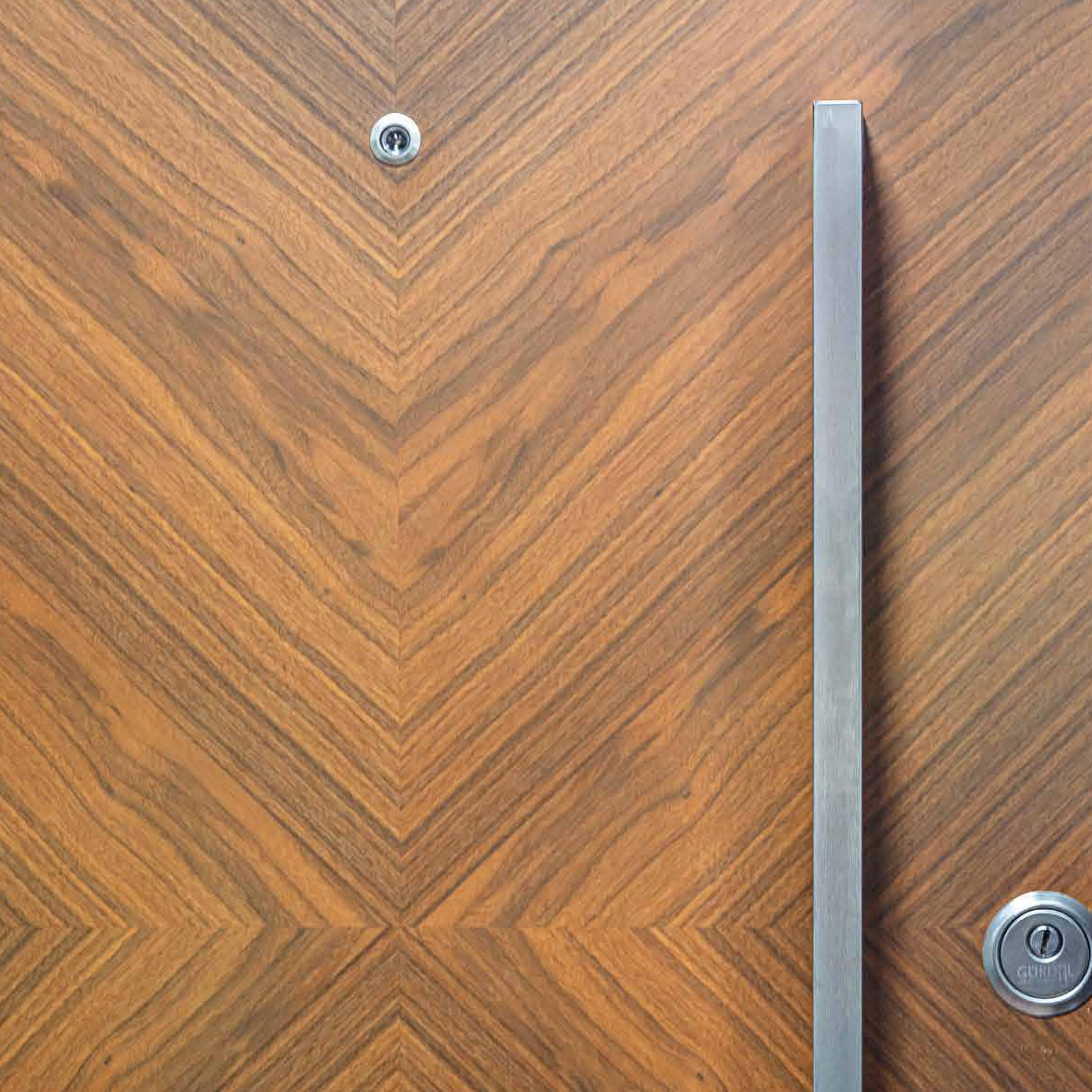

TILLIS



ARACHIS



ARACHIS



ILEX

ILEX

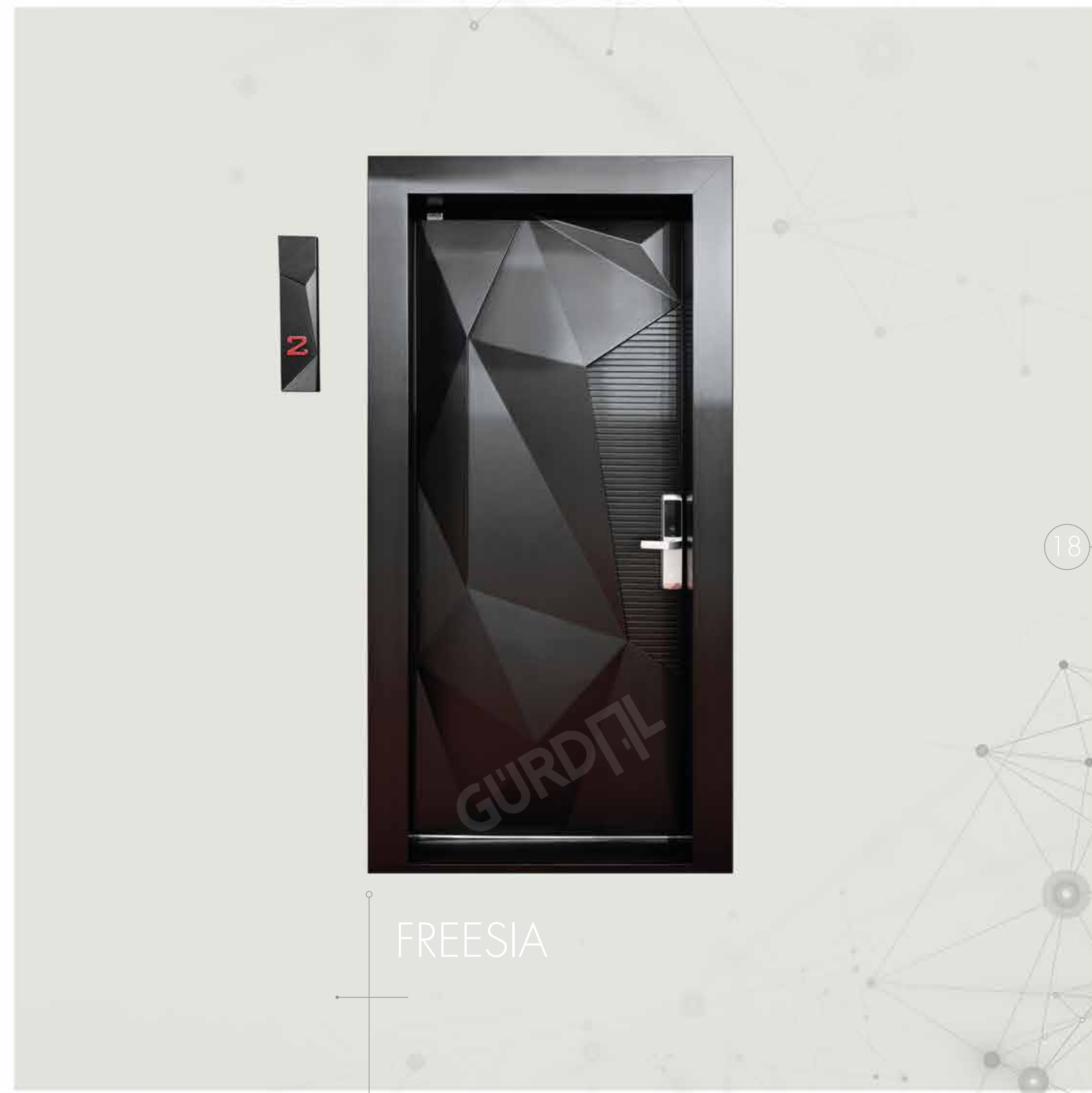

FREESIA

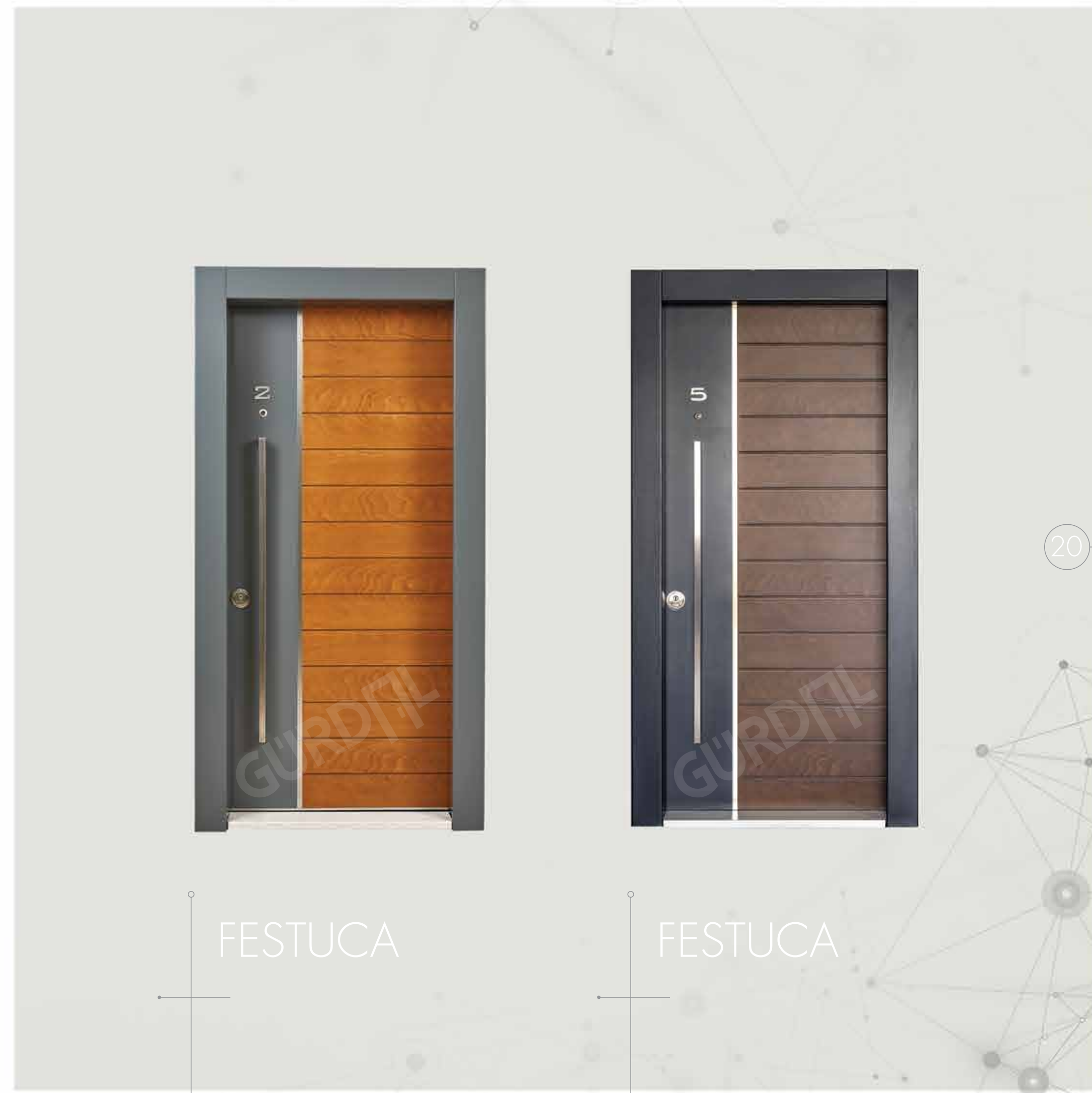

FESTUCA

FESTUCA



SOLANUM

SOLANUM



RUTA

LONICERA

ORYZA



LILIUM

CITRUS

PIMENTA

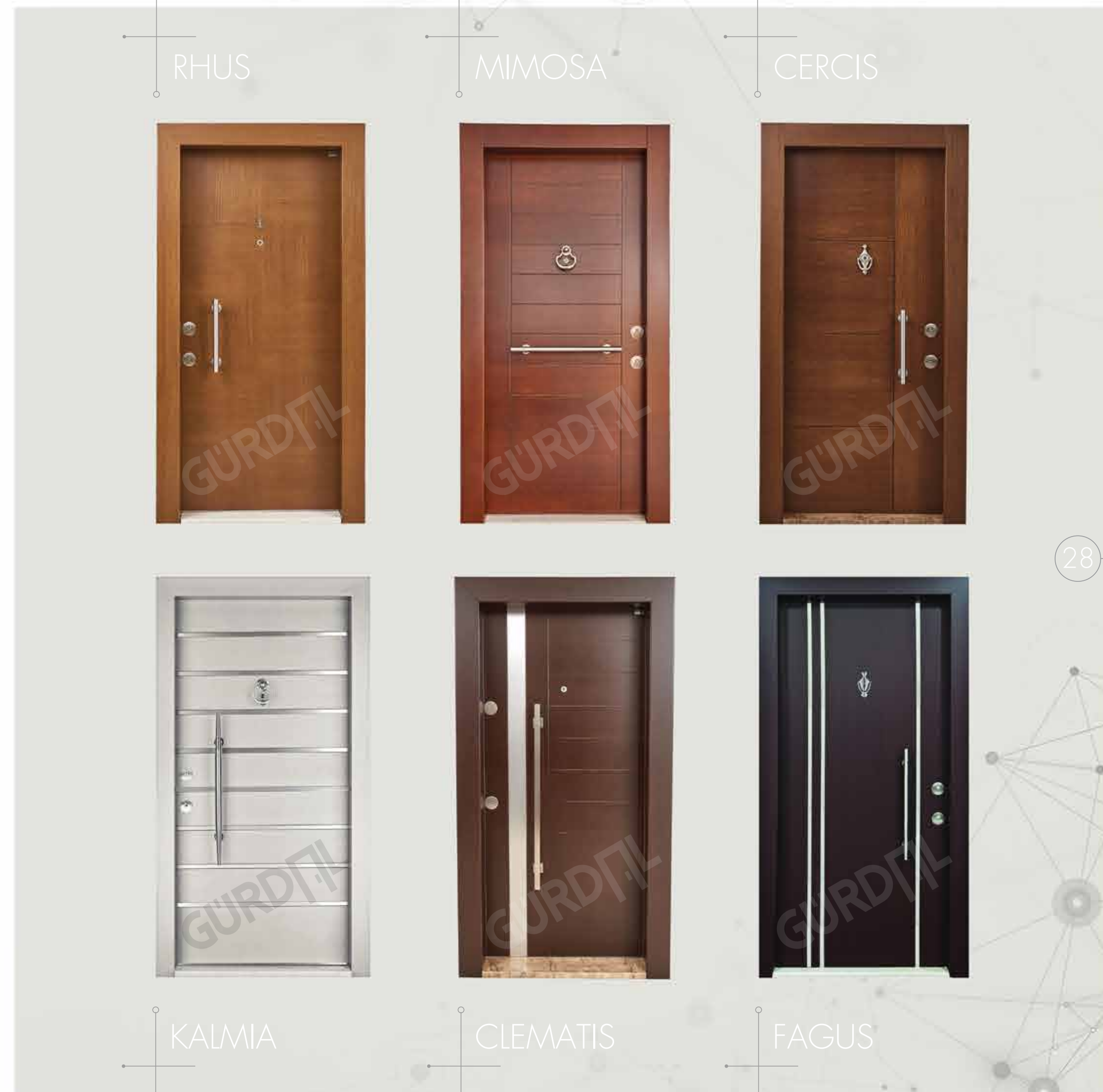

RHUS

MIMOSA

CERCIS



KALMIA

CLEMATIS

FAGUS

29



ERITA

30



CYCAS

31



CILIVIA



ARUM



32

AVENA

33



CAMELLIA



CAMELLIA

34



AGATIS



AGATIS

35



LILIUM



LILIUM



LILIUM

36



LILIUM



LILIUM



PERSEA

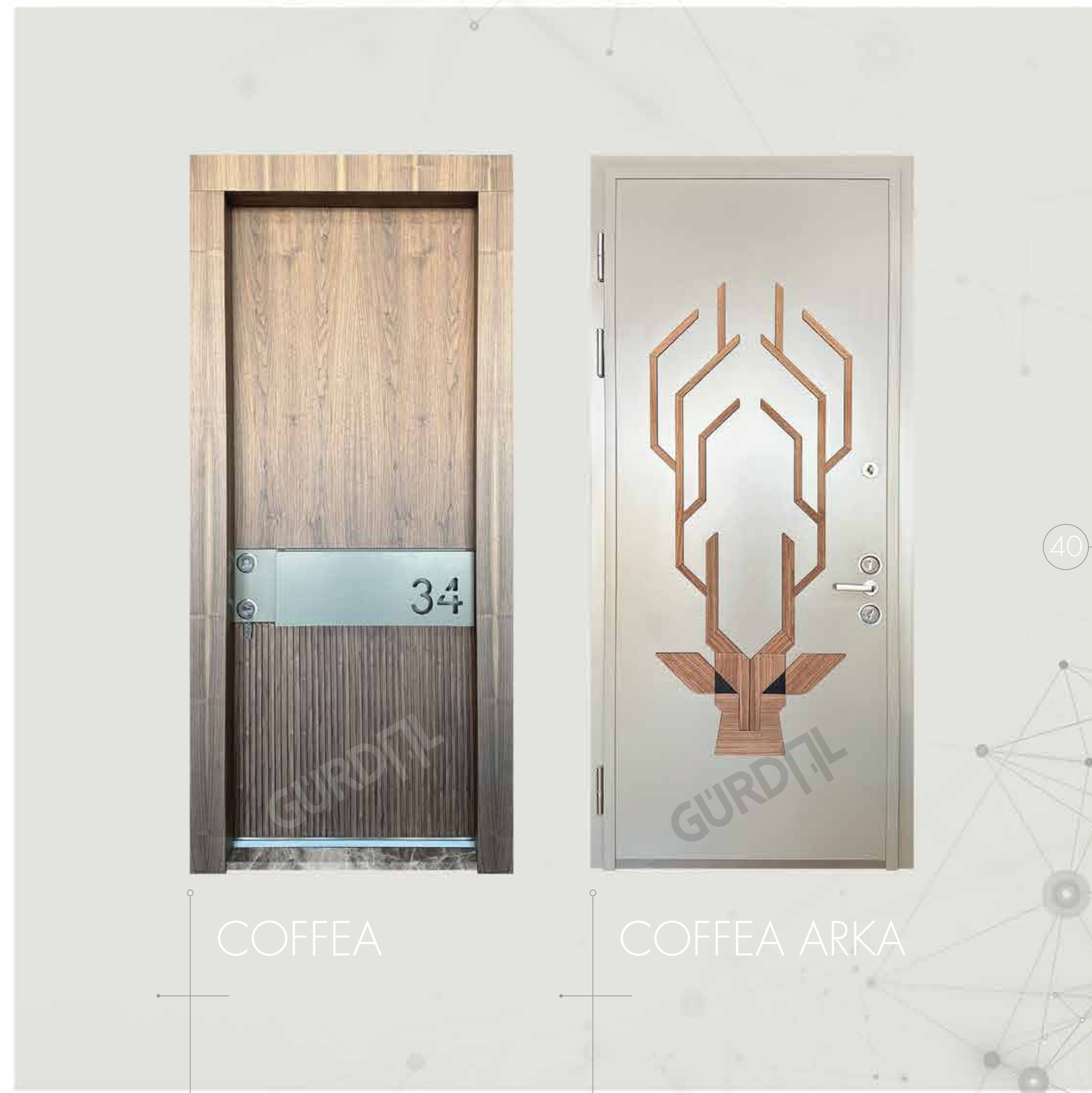

COFFEA

COFFEA ARKA



MORACEAE

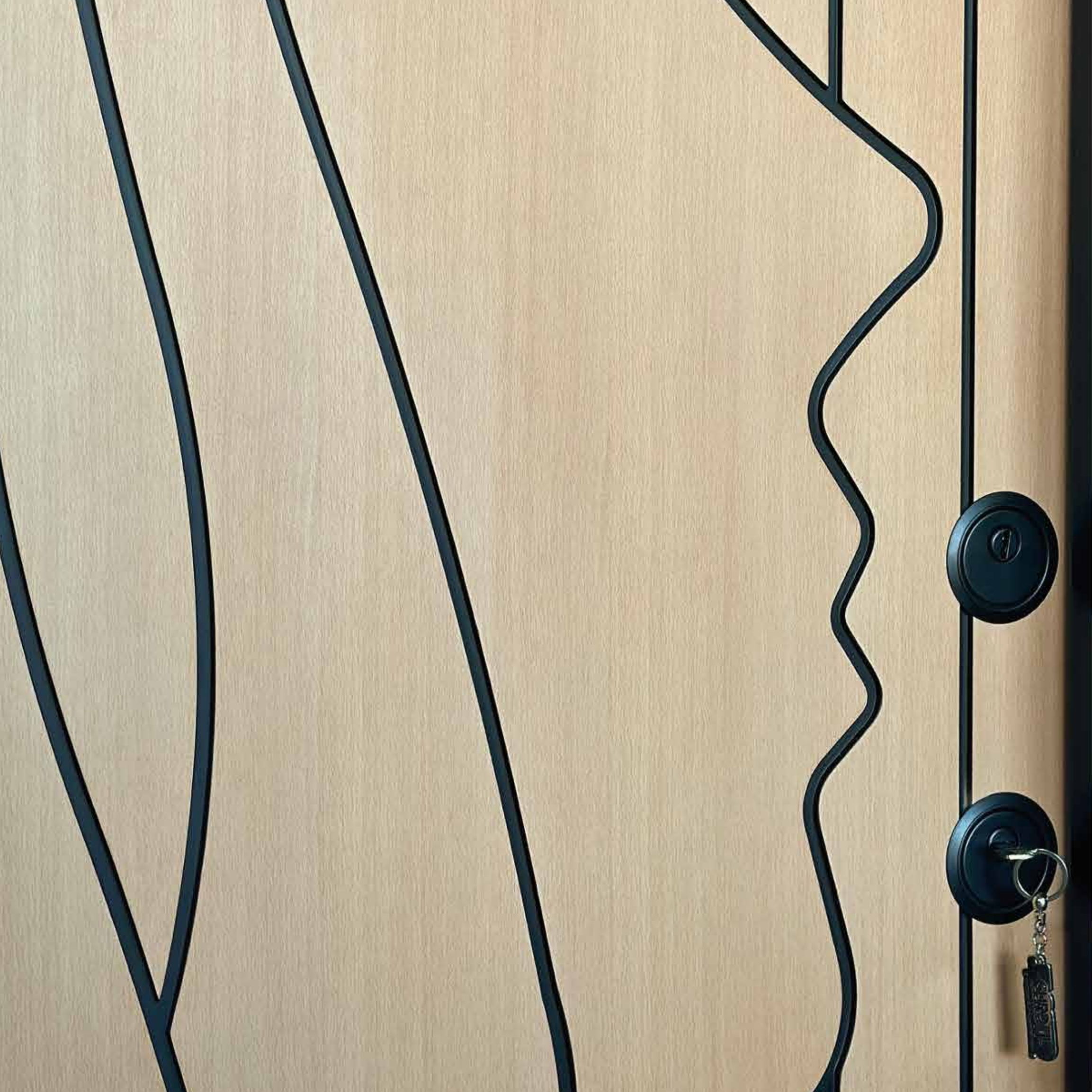

FEMINA



FEMINA ARKA



CUPRESSUS

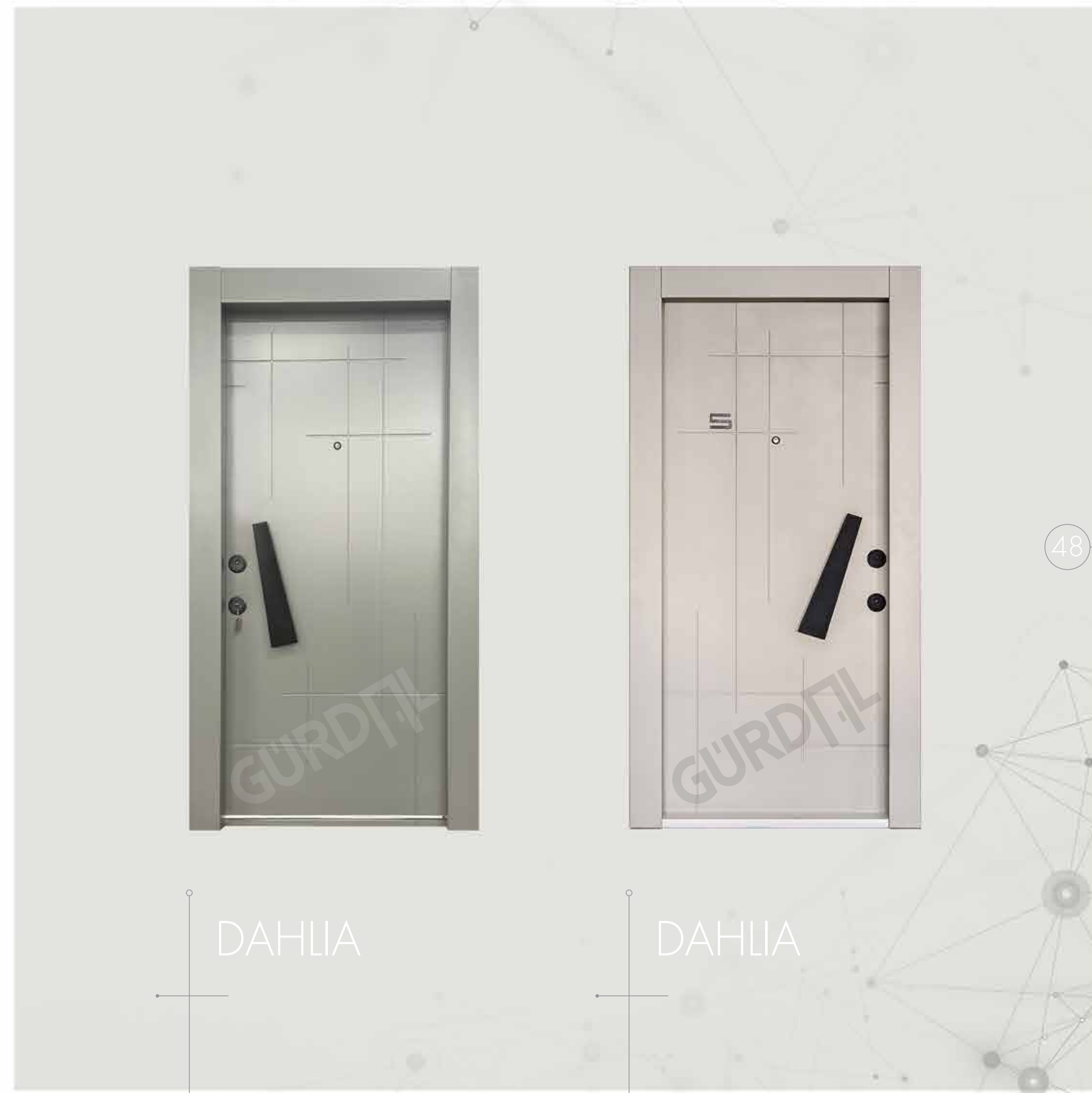

DAHLIA

DAHLIA



CEDRUS

CEDRUS

CEDRUS

51



PANAX

52



MARANTA

{ KLASİK }

CORYLUS
KLASİK DAİRE GİRİŞ KAPILARI

GURDOL
CELİK KAPI SİSTEMLERİ

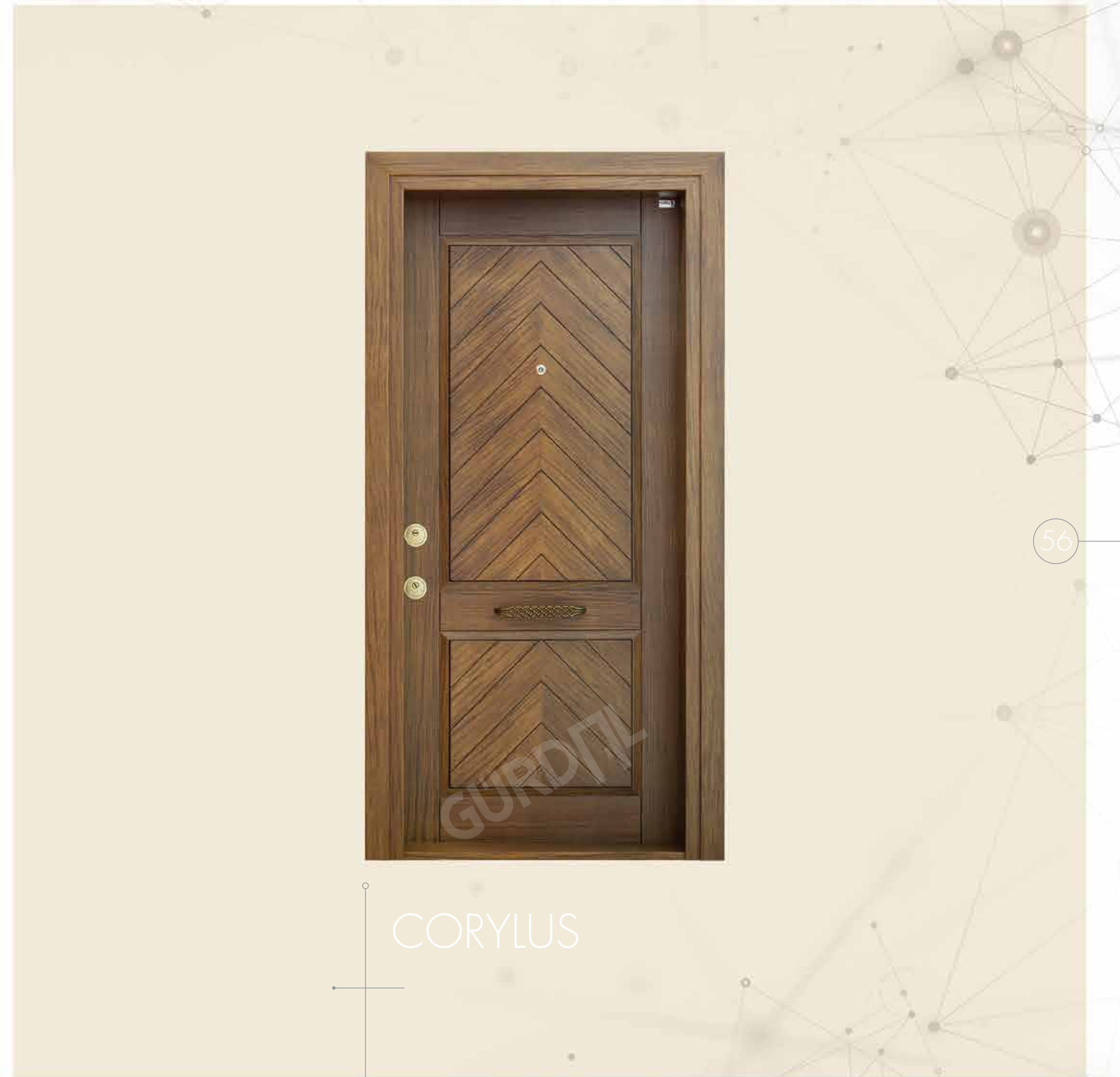
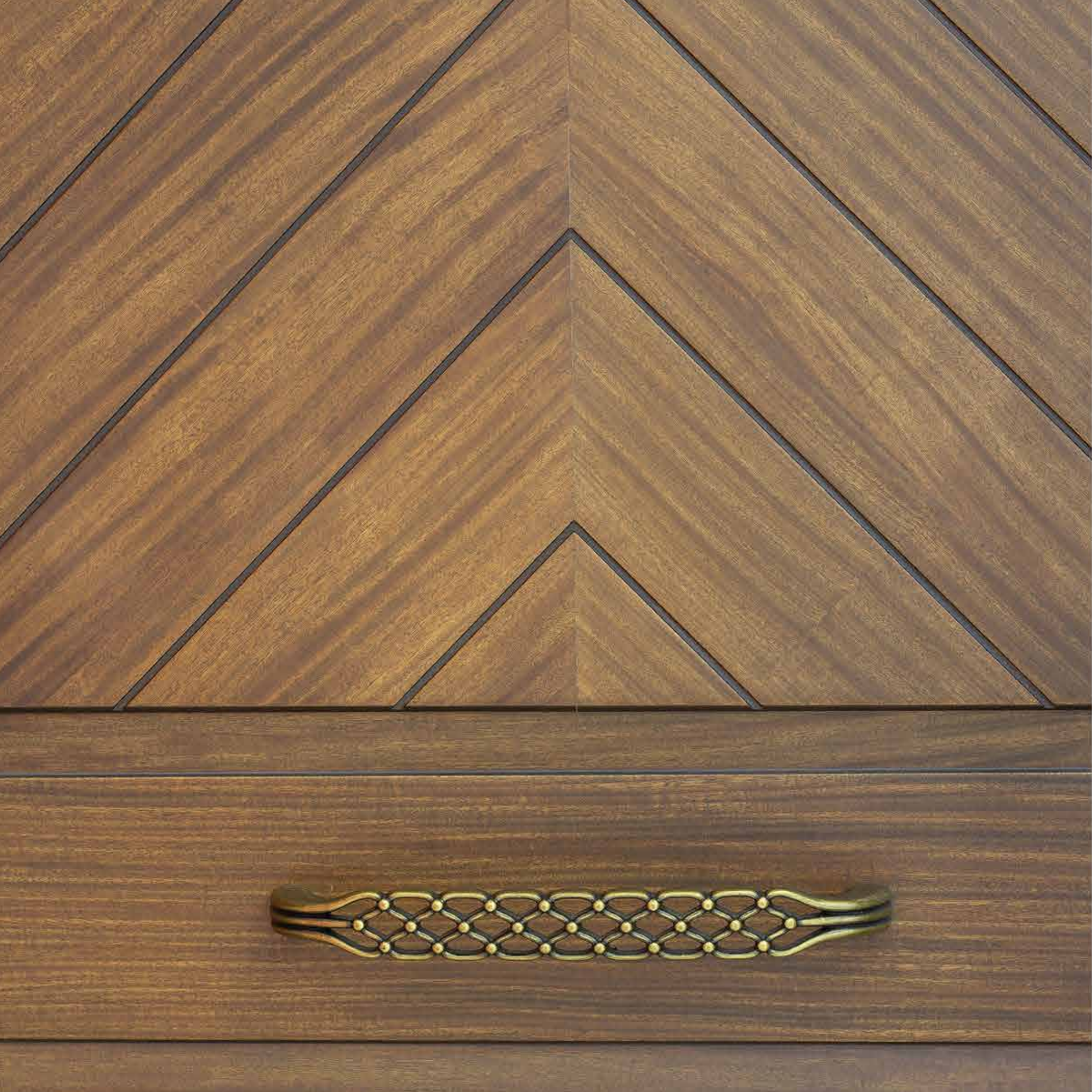

CORYLUS



ARTEMISIA



FATSIA



FATSIA



FATSIA



TAMARIX

TAMARIX

TAMARIX



BRASSICA

BRASSICA

BRASSICA



CATHOYA

CATHOYA

CATHOYA



CELLA

CELLA



CARPINUS

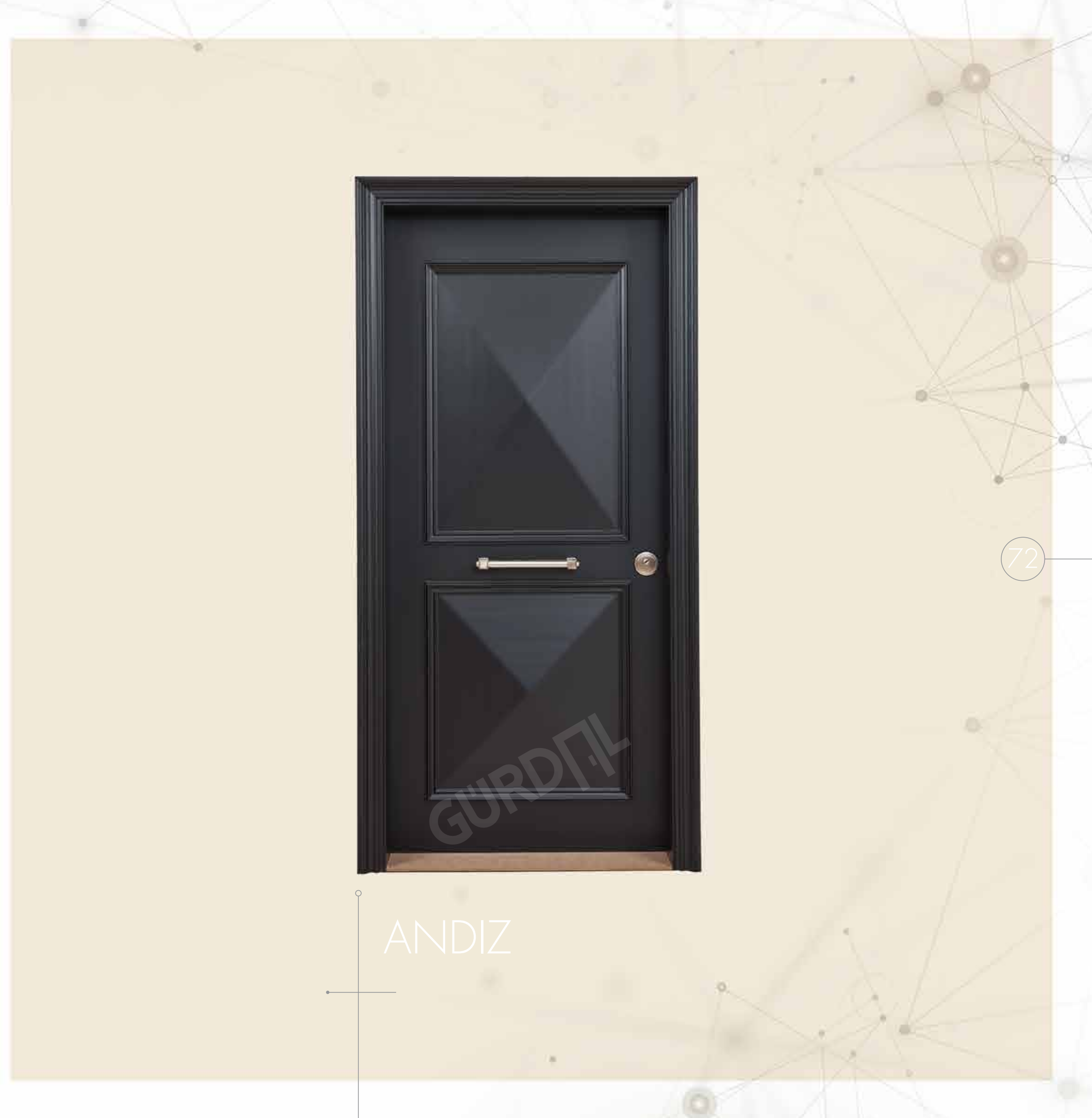

ANDIZ



PAPHANUS



LONICERA



TOBIRA



VARIEGATA

81



LARIX



LARIX



SESAMUN



SESAMUN



ACAJA

82



83

84

ABIES

MELIA

BETULA

MORUS

MORUS

GÜVEN KAZANAN KAPILAR

[BİNA TİPİ]



PIECA
BİNA GİRİŞ KAPILARI

GURDOL
ÇELİK KAPI SİSTEMLERİ

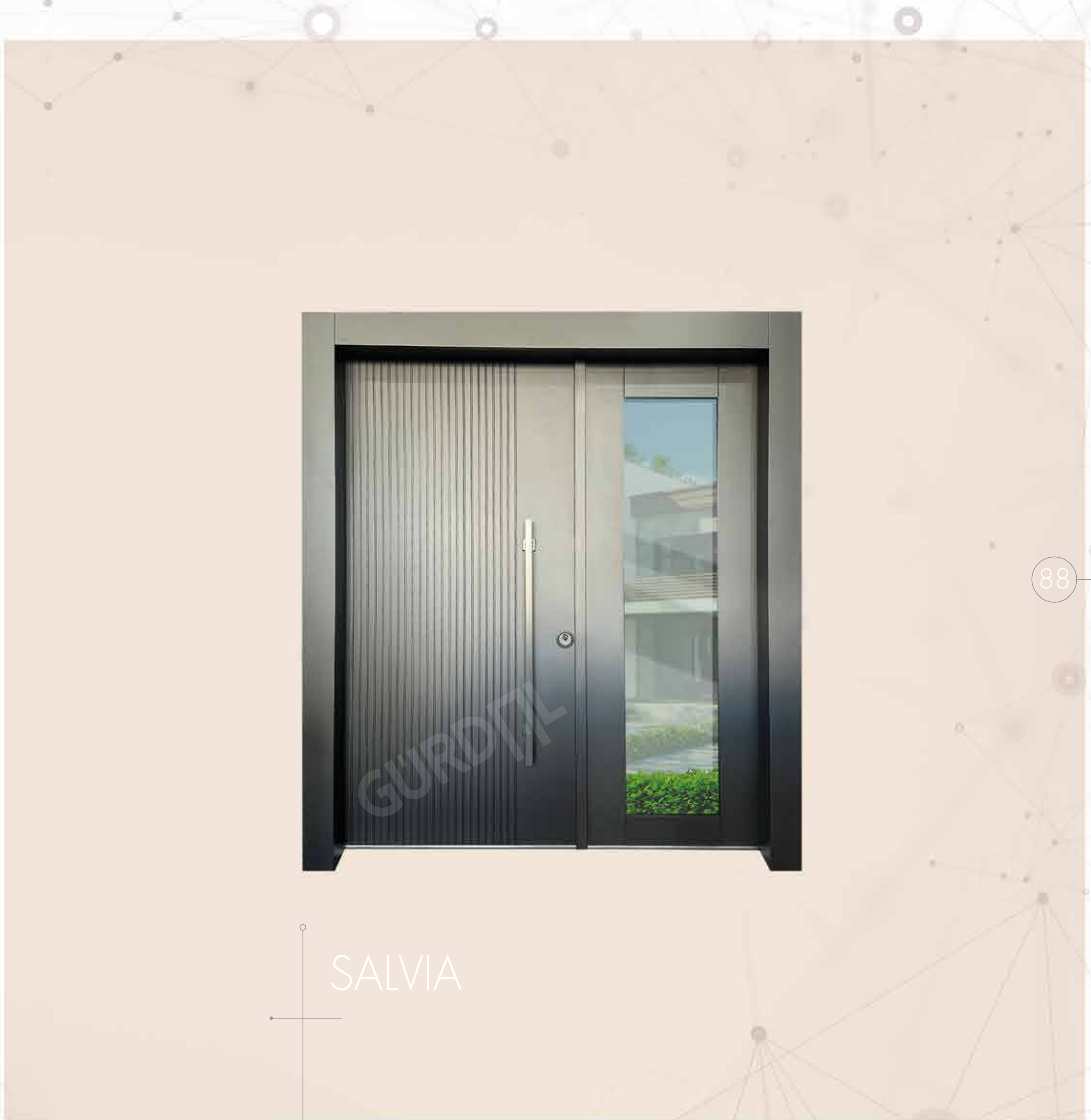

SALVIA

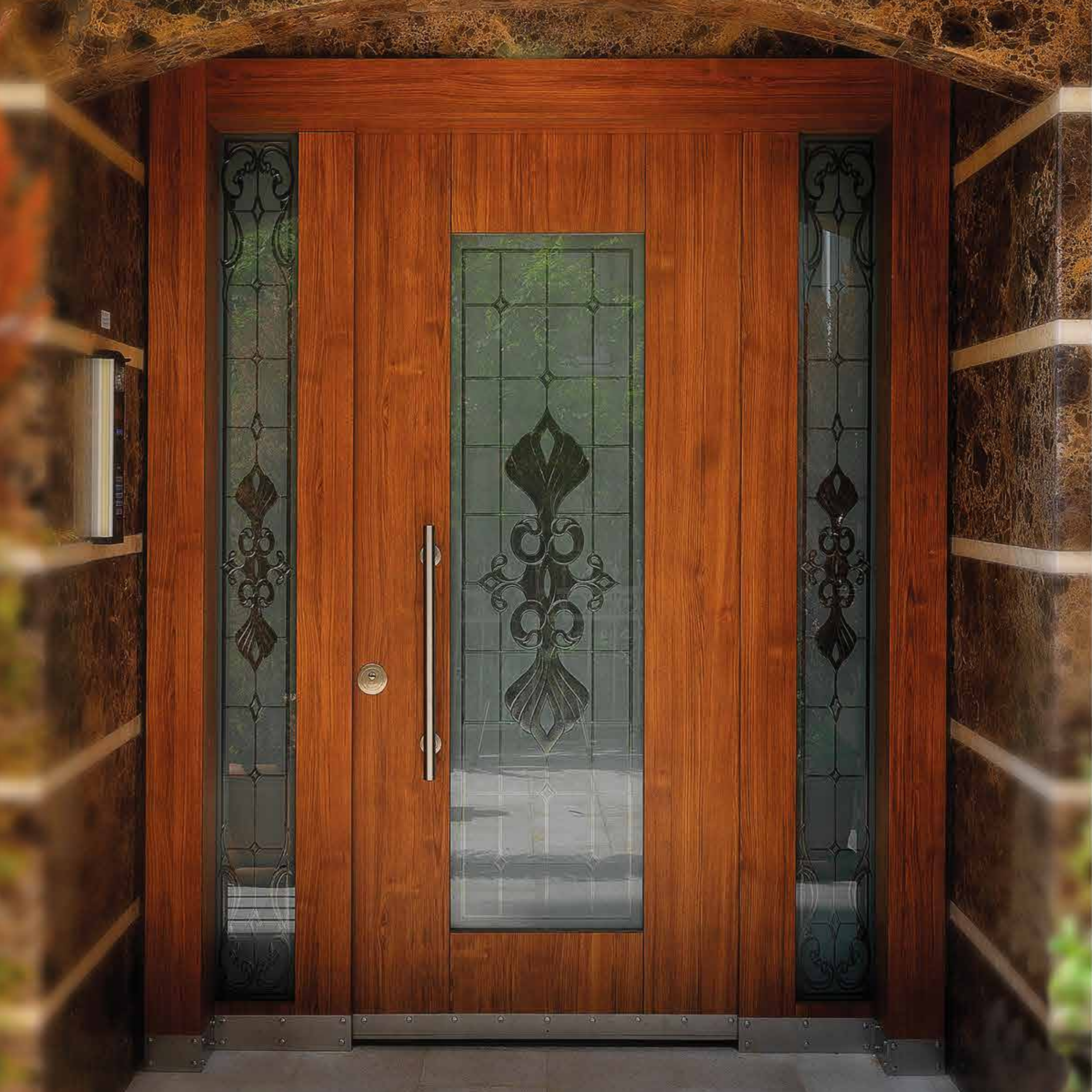

CROCCUS



PIECA



PIECA



PIECA



PIECA

VİLLA YIĞIT No-5

PINUS



PINUS

PINUS



PINUS



PINUS

PINUS



PIECA

DRAPA



LARIX



LILIUM

LILIUM

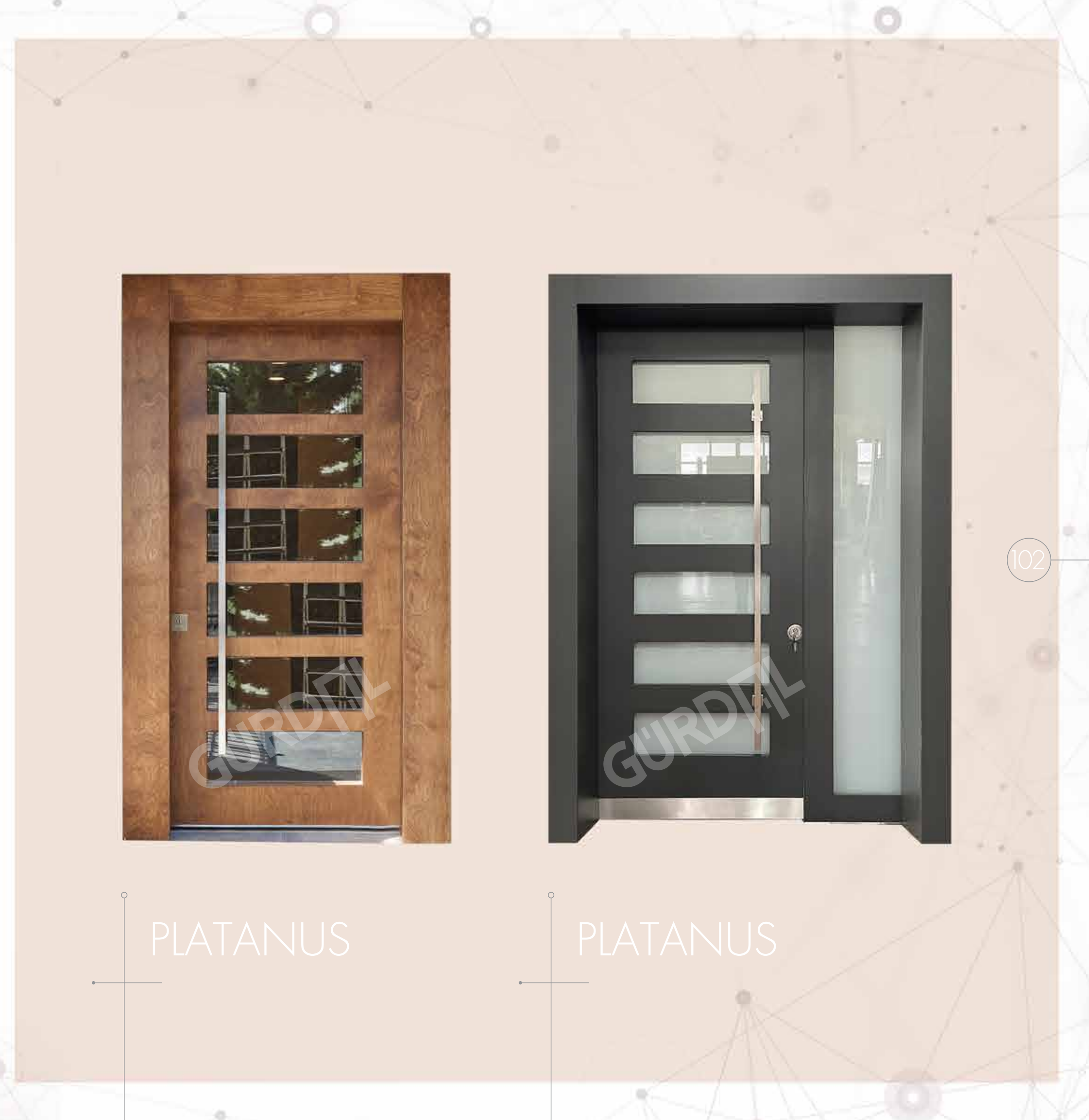

PLATANUS

PLATANUS



ZELKOVA



RIBES



PLATANUS



PLATANUS



LILIUM



DRAPA



PIECA



PLATANUS

RUHNUNUZU
YANSITAN
SANATSAL
KAPILAR

(VILLA TİPİ)

LARIX
VİLLA GİRİŞ KAPILARI

GÜRDÜL
ÇELİK KAPI SİSTEMLERİ



SEQUORIA



SAMBUCUS



SALVIA



PIECA

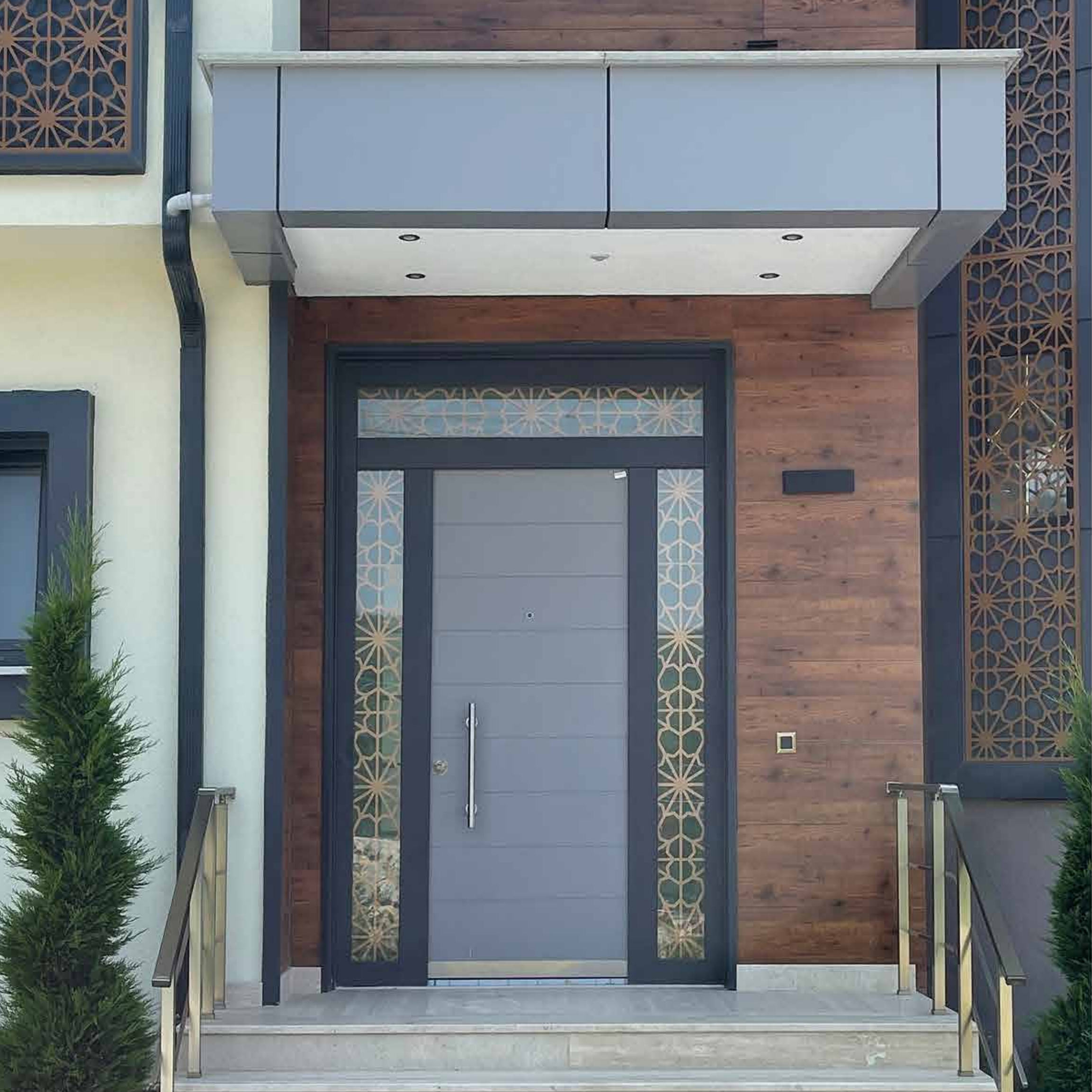

LAURUS



LAURUS



SPIERA



BONSAI



LAURUS

JUGLANS



QUERCUS



123

GURDITIL

JUPINE



JUPINE

GURDITIL



CYDONIA

124

GURDITIL



ZELKOVA



FATSIJA



SYRINGA



ILEX

PYRUS



PYRUS



MORUS



MORUS



YUCCA



MACLURA



MORUS



CELLA

HYDRABEA



20

LILIUM



CELLA



DAHLIA

GURDITIL

GURDITIL

GURDITIL



LUTEUM

137



MYRTUS

138



EPILOBIUM



CAMALLIA

KALİTE, DAİMA ÇİZGİ ÜSTÜNDE OLMAKTIR...



Değişime sadece ayak uyduranların geleceğe emin adımlarla yürüyebileceği gerçeğinden hareketle; sektörün ve müşterilerimizin sınırsız hayaller kurmalarına yardımcı olmak adına kendimizi yenileyerek aşmak, kalite çizgimizi yükseltmek imkansız tasarımları imkanı hale getirmek, üretim prosesinde sınırları zorlayarak hayal edileni gerçeğe dönüştürmek, mekanlara ve yapılara farklı bir boyut ve estetik kazandırmak, tüm bu kazanımları sizler için "özel" hale getirebilmek için bugünkü enerjimizi, yarımların sinerjisiyle birleştiren inovatif ürünlerimizde yepyeni bir markayla çıktığımız bu yolda geleceğe daha bir umutla bakmanın haklı gururunu yaşıyoruz.

ARTIK KAPIDA "YENİ" BİRİ VAR!

Kapılarımızı sınırsız hayallerinize açıyoruz!

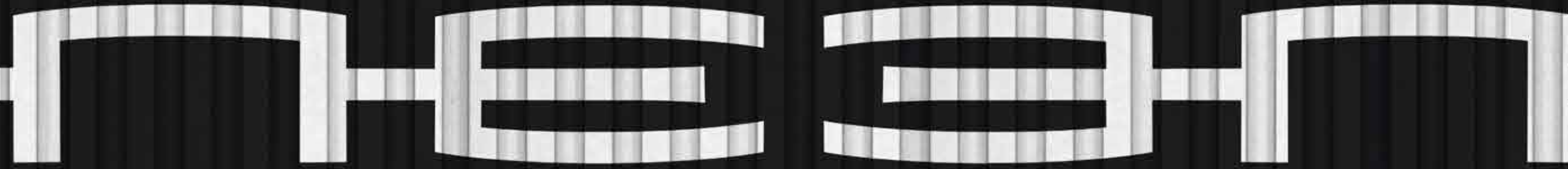

STEEL DOOR SOLUTIONS

HAYALLERE
İLHAM VEREN

İNNOVATİF

KAPILAR

PIVOT TİPİ

DIOSCOREA

PIVOT DAİRE GİRİŞ KAPILARI

 NEON
STEEL DOOR SOLUTIONS

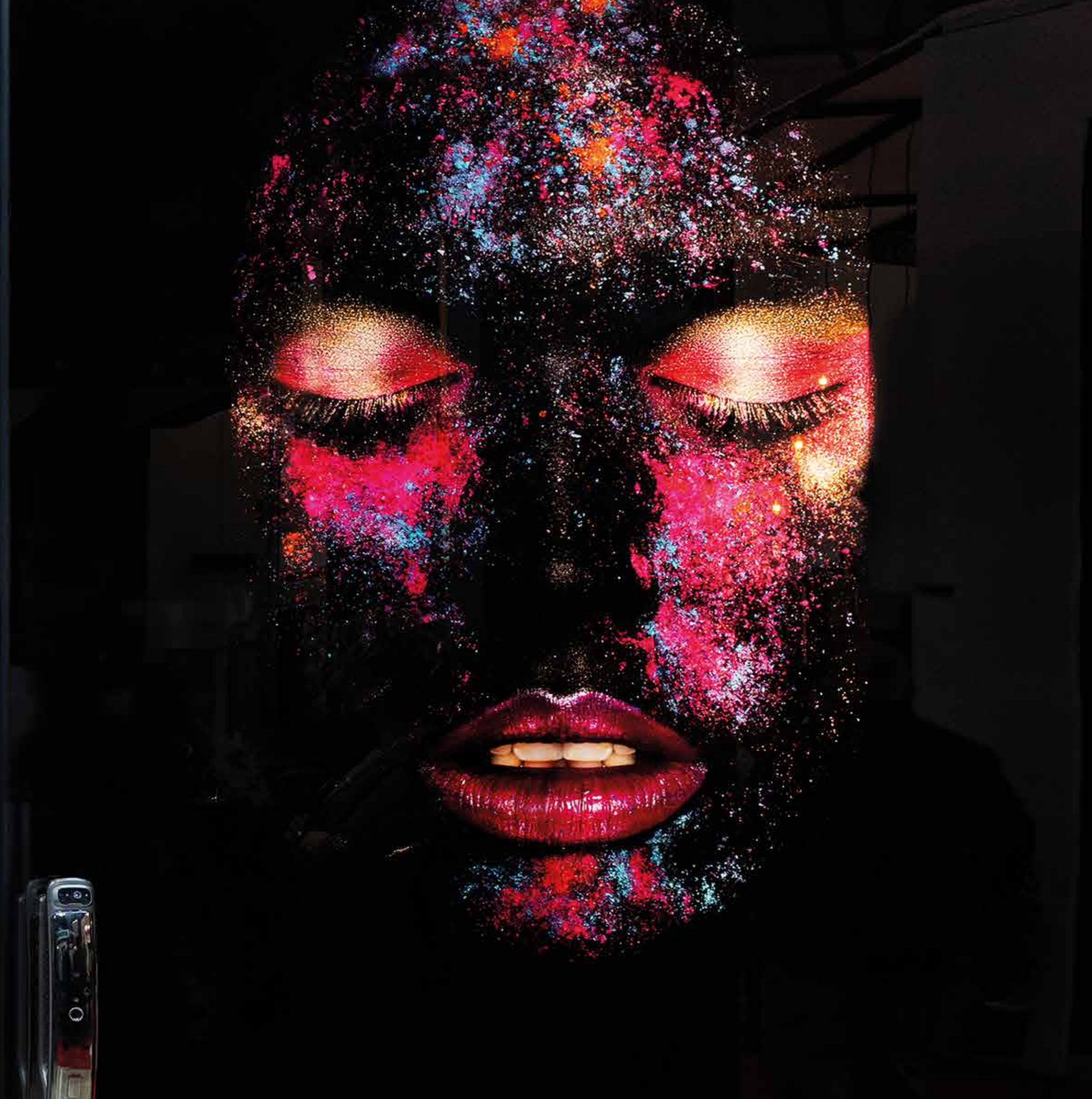

PIVOT

ZIZANIA

NEBIL

PIVOT

ZIZANIA ARKA

NEBIL

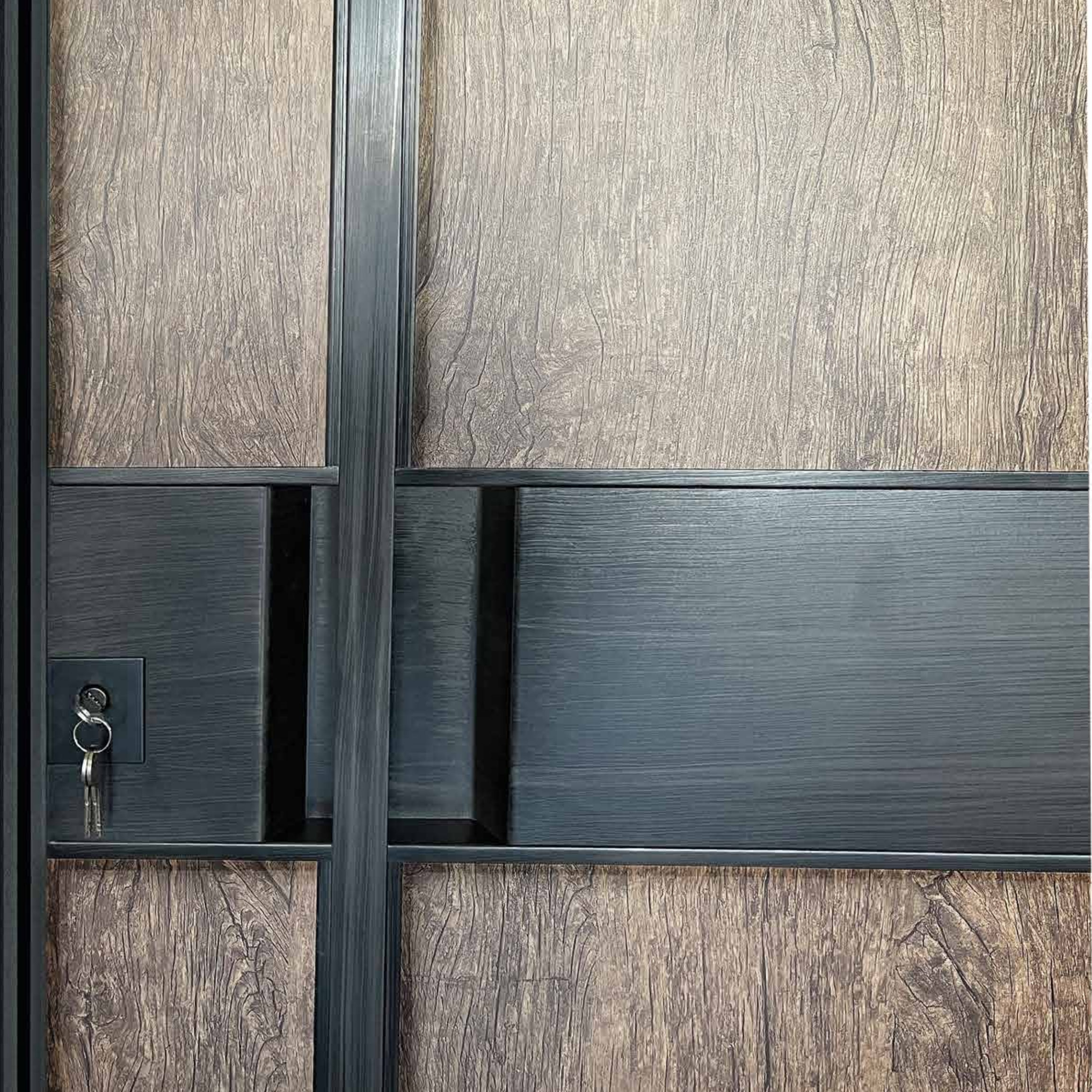

PIVOT

PIVOT

PELERGONIUM



PIVOT
-mesin-

CARICA



CASTANEA

PIVOT

PIVOT

149



DIOSCOREA

PIVOT

PIVOT

150



BINA

ZINGIBER

NEBBI

151



BINA

PONTICA

NEBBI

152



VILLA

FRAXINUS

FRAXINUS

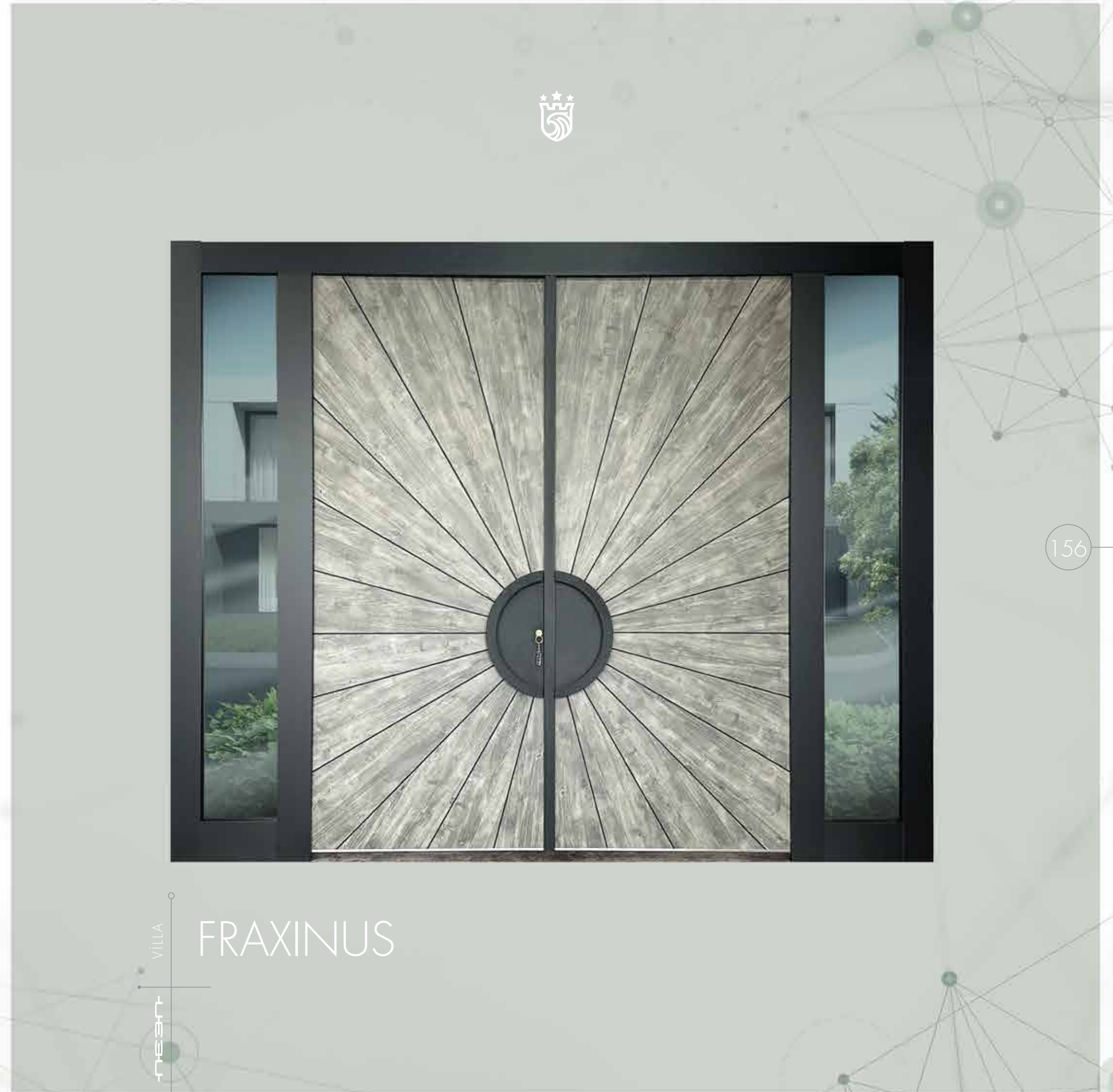

VILLA

FRAXINUS

FRAXINUS



B 580

VILLA
-MEBIL-

SOLANUM





VILLA
-hordeum-

HORDEUM

HAYATA AÇILAN KAPILAR

{ ACIL ÇIKIŞ TİPİ }



RENKLİ
ACIL ÇIKIŞ KAPILARI

GURDOL
ÇELİK KAPI SİSTEMLERİ



TEKNIK

TEKNOLOJİ,
KALİTE VE
TECRÜBEYE
EKLENEN
'İNOVATİF'
SANATSAL
KAPILAR...

BİLGİLER

GURDOL
CELİK KAPI SİSTEMLERİ



NEEN

STEEL DOOR SOLUTIONS

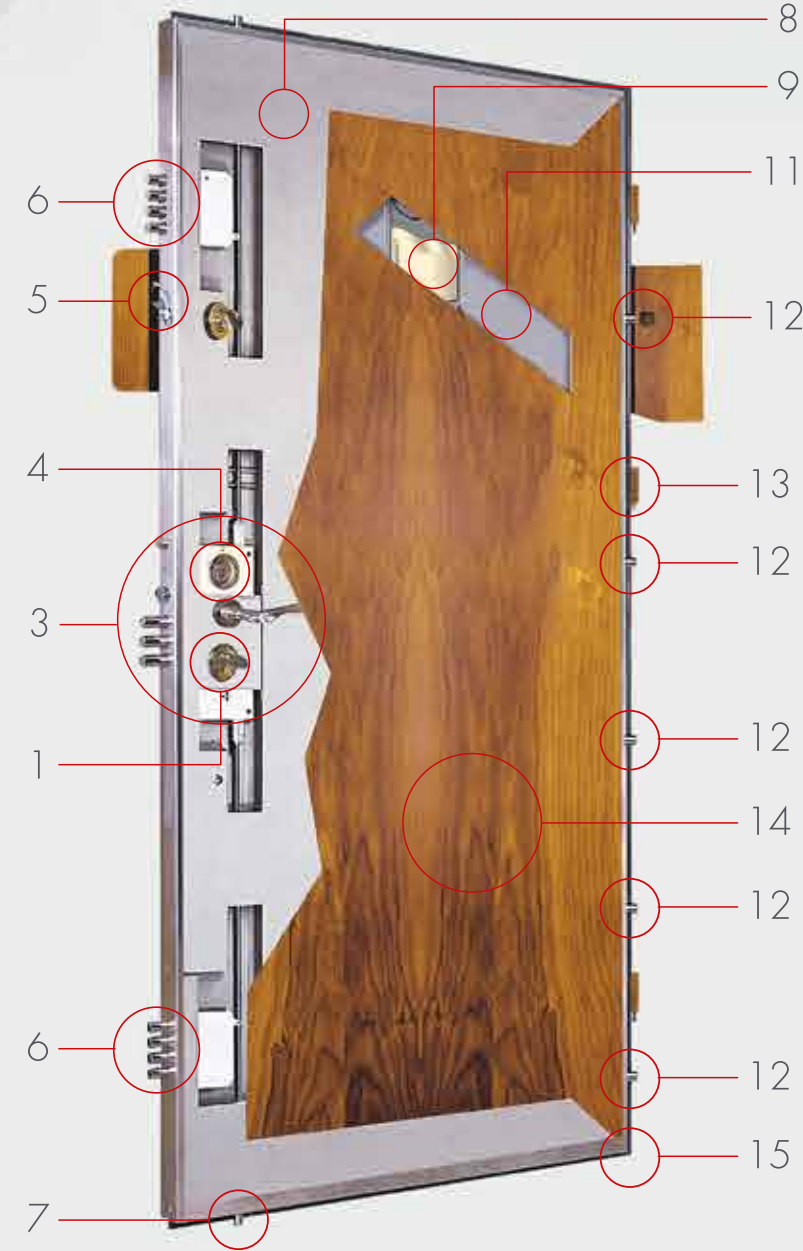

- 1 Merkezi kilit sistemine bağlı hareketli alt ve üst çelik pimler
Top and bottom moving steel locking pins connecting to the multi-lock
- 2 İzinsiz kopyalanamayan özel üretim anahtar ve kilit silindiri
Lock and key cylinder with protection against unpermitted copying.
- 3 Darbelere dayanıklı silindir kalkanı ile korunan 4 koldan 20 ayrı noktadan kilitleyebilen merkezi kilit sistemi
Bump Proof Multi-Lock System lockable from 4 sides, 20 seperated points.
- 4 İçeriden kilitleme kolaylığı sağlayan yardımcı kilit
Auxiliary lock available which can be locked from inside
- 5 5 cm açılabilir gizli emniyet kelepçesi
Hidden security door guard hook openable 5 cm.
- 6 Merkezi kilit sistemine bağlı dörtlü çelik pimler krom kaplamalarıyla daha da sağlam
4 drive pins connected to multi-lock system with chrome plating are stronger and more durable
- 7 Merkezi kilit sistemine bağlı hareketli alt ve üst çelik pimler
Top and bottom Moving steel locking pins connecting to the multi-lock
- 8 60 mm çelik sacdan yapılmış, kurşun geçirmez, her türlü darbeye dayanıklı gövde
Bullet and bump proof body manufactured from 78mm. steel sheet.
- 9 Ses ve ısı geçirmeyen izolasyon sağlayan cam yünü
Sound & Heat Proof glass wool.
- 10 Dışarıya 180° açı ile görme imkanı sağlayan gözetleme dürbünü ve kapı taktığı
Door viewer with 180° sight and door knocker.
- 11 Darbelere dayanıklı gövdeyi oluşturan dikey omega destekler
Vertical omega supports forming the body
- 12 Çelik kapıyı arkadan 5 noktadan kasaya bağlayan çelik pimler ve çelik pim yuvası
Steel pin and pin sockets connecting the steel door to the frame from 5 points at the back side
- 13 Çelik kapıyı 3 noktadan bağlayan kapı ile aynı desende kaplanan kapı menteşesi
Door hinge connecting the door from 3 points. The Door hinges are in the same pattern colour as the door.
- 14 MDF ve ahşap kaplamada zengin renk ve desen çeşitliliği
Broad and rich colour and pattern options @ MDF and wood siding
- 15 Toz, rüzgar, ses ve haşere girişini engelleyen gömme yuvalı kauçuk conta (opsiyonel)
Door bottom seal with embedded socket in orderto prevent the entry of sand, wind, sound and insects.

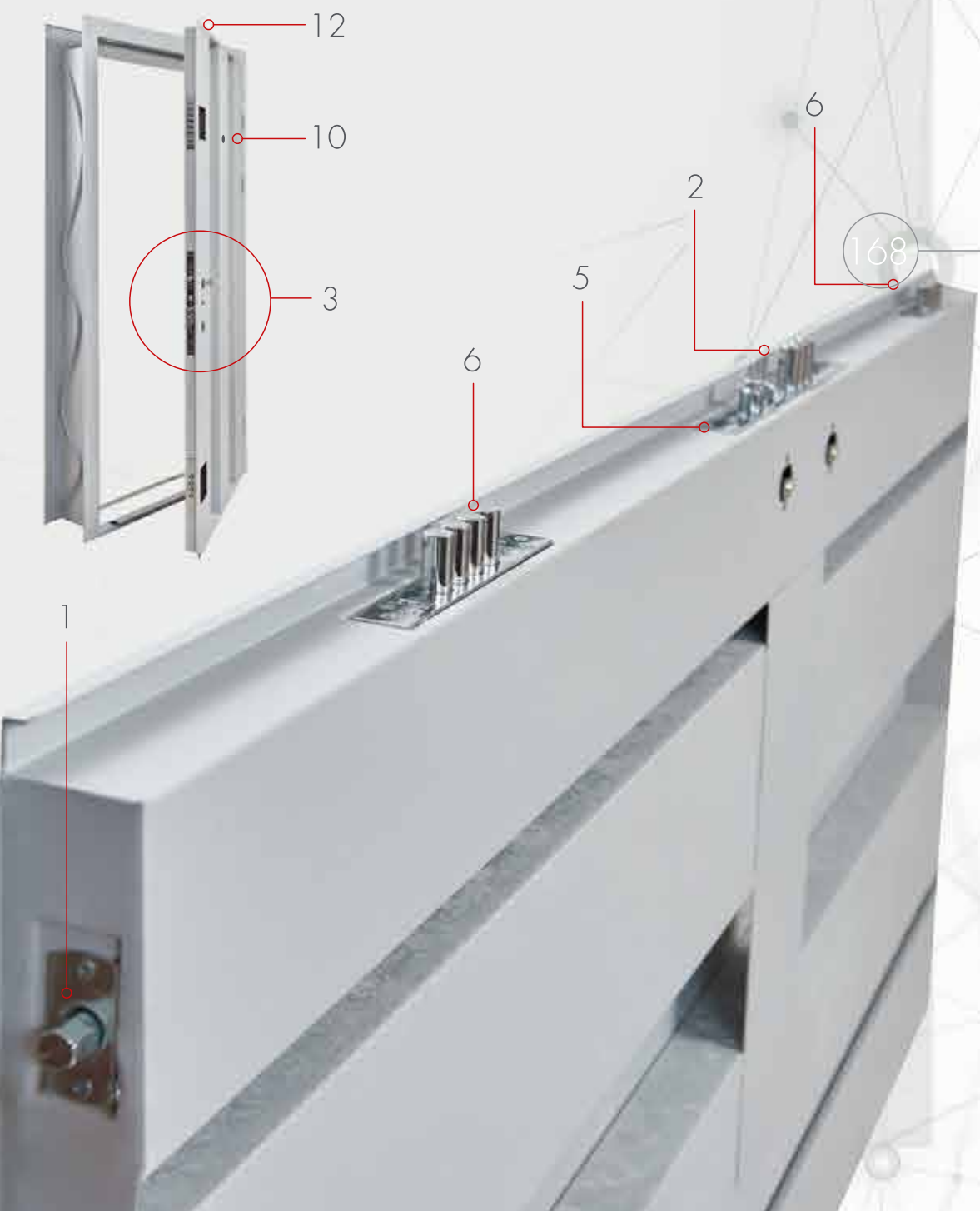
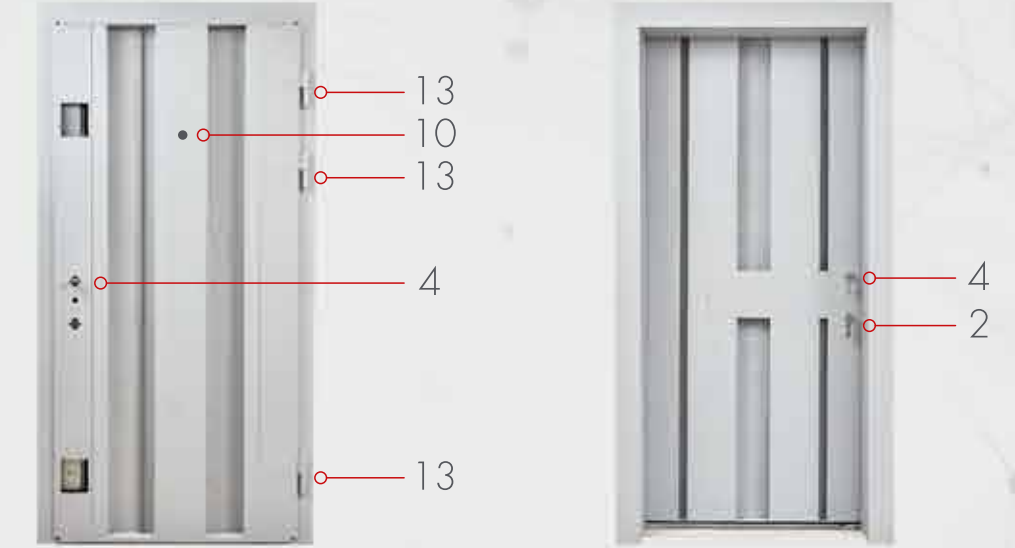

167

168

- TSEK Belgeli TS. 1263 (ve DIN 4102)'ye uygun
Certified by TSEK comply with TS. 1263 (and DIN 4102)
- Özel Dizayn
Special Design
- Tamamen Yanmaz Malzeme (A Sınıfı)
Fire Proof Materials (A Class)
- Özel Duman Geçirmez Contalı
Smoke Proof Jointing
- Panik Bar ya da Push Bar Seçeneği
Panic Bar or Push Bar Option
- Özel Menteşe
Special Hinges
- Sabit veya Ayarlı Kasa Her Ölçüde
Fixed & Adjustable Frames @ all measure ments
- İstenilen Renkte Elektrostatik Boya
Electrostatic coating in all required colours
- Kapılar Camlı veya Camsız, Camlar Isıya Dayanıklı
Glass Type (Pane) or Non-Glass Type Doors. Glass Types are Heat Proof
- Tek veya Çift Kapı Seçeneği
Single or Double Door Options
- Dolgu Malzemesi TS 1263'e Uygun Yanmaya Yapı Malzemelerinden Oluşmaktadır.
Filling materials are made from the fire proof materials complying with TS 1263.

